

FLYTE

FLS208

Flyte 10" Rain Showerhead with 18" Wall Mounted 90 Degree Shower Arm



SHOWN IN FLYTE 10" RAIN SHOWERHEAD WITH 18" WALL MOUNTED 90 DEGREE SHOWER ARM | FLS208

TECHNICAL DETAILS

Adjustable Versus Fixed Spray: Fixed
Fittings Hole Diameter: 1 1/4"
Inlet Connection Size: 1/2"
Inlet Connection Type: Male NPT
Pivot: Y
Primary Material: Brass
Restricted Maximum Flow Rate: 1.75 gpm
Water Pressure Maximum: 85.0 psi
Water Pressure Minimum: 20.0 psi
Water Pressure Recommended: 45.0 psi

INSPIRATION

Pure Modernism. Like minimalist works of art, the elegant proportions of these light, fluid elements bring sculptural reference to a room.

CODES & STANDARDS

PRODUCT FEATURES

Made of Brass

Features a swivel 10" rain showerhead with easy clean rubber nozzles

Includes a 18" wall mounted 90 degree shower arm

Stocked in Brass, Chrome and Nickel

Rain showerhead available in 1.75gpm (6.6L/min) flow rate

CERTIFICATIONS

PRODUCT (NOTES)

FLYTE

FLS208

Flyte 10" Rain Showerhead with 18" Wall Mounted 90 Degree Shower Arm

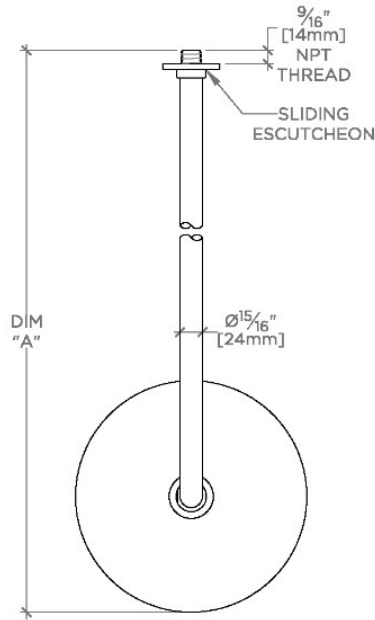

TOP VIEW

SCALE: 1 1/2"=1'-0"

STYLE NO.	DIM "A"	DIM "B"
FLS208	23 7/16" [595mm]	18 9/16" [472mm]
ISS208		
FLS209	27 3/8" [696mm]	22 9/16" [573mm]
ISS209		

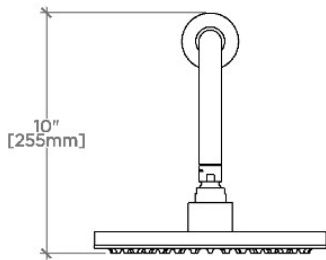

FRONT VIEW

SCALE: 1 1/2"=1'-0"

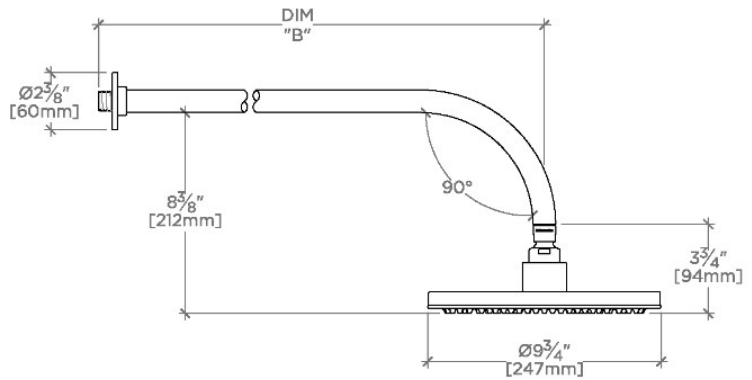

SIDE VIEW

SCALE: 1 1/2"=1'-0"