

FULTON MODERN PLP PULLDOWN FAUCET / ANGELD SPOUT

10370

- Max Counter Thickness 2-3/8"
- Minimum Install Hole Size 1-1/2"

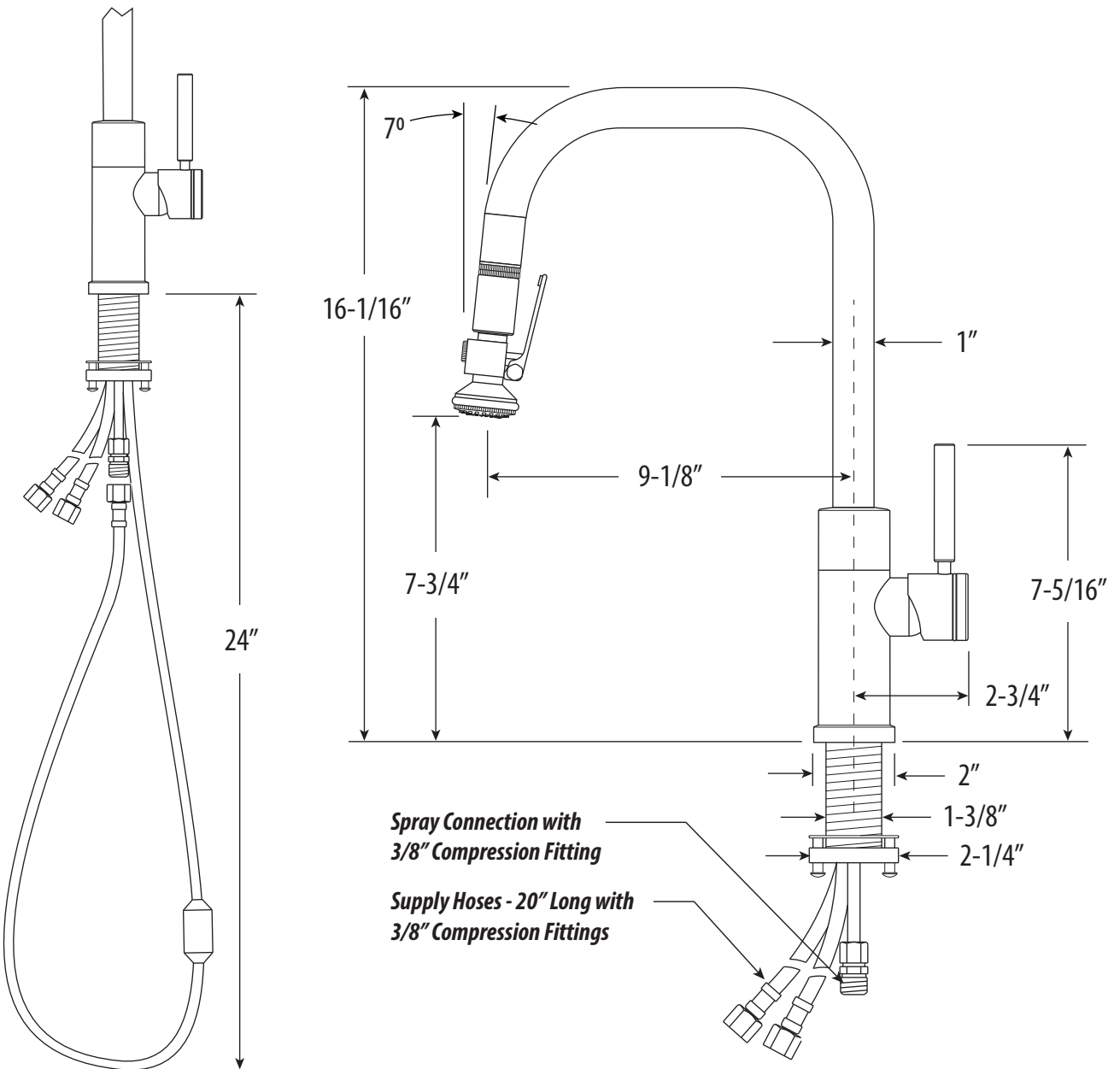

DIMENSIONS MAY VARY AND ARE SUBJECT TO CHANGE. NO RESPONSIBILITY IS ASSUMED FOR USE OF SUPERCEDED OR VOIDED DATA