

HENRY

HNS335

Henry 2 3/4" Showerhead with Adjustable Spray with 8" Wall Mounted 45 Degree Shower Arm



SHOWN IN HENRY 2 3/4" SHOWERHEAD WITH ADJUSTABLE SPRAY WITH 8" WALL MOUNTED 45 DEGREE SHOWER ARM | HNS335

TECHNICAL DETAILS

Adjustable Versus Fixed Spray: Adjustable Spray
Fittings Hole Diameter: 1 1/4"
Inlet Connection Size: 1/2"
Inlet Connection Type: Male NPT
Pivot: Y
Primary Material: Brass
Restricted Maximum Flow Rate: 1.75 gpm
Water Pressure Maximum: 85.0 psi
Water Pressure Minimum: 20.0 psi
Water Pressure Recommended: 45.0 psi

INSPIRATION

Influenced by the connection of industry and art Henry easily transitions between modern, traditional, utilitarian and classic settings.

CODES & STANDARDS

PRODUCT FEATURES

Made of Brass

Features a swivel 2 3/4" showerhead with two adjustable spray patterns

Includes a 8" wall mounted 45 degree shower arm

Stocked in Brass, Chrome and Nickel

Showerhead available in 1.75gpm (6.6L/min) flow rate

CERTIFICATIONS

PRODUCT (NOTES)

WATERWORKS

HENRY

HNS335

Henry 2 3/4" Showerhead with Adjustable Spray with 8" Wall Mounted 45 Degree Shower Arm

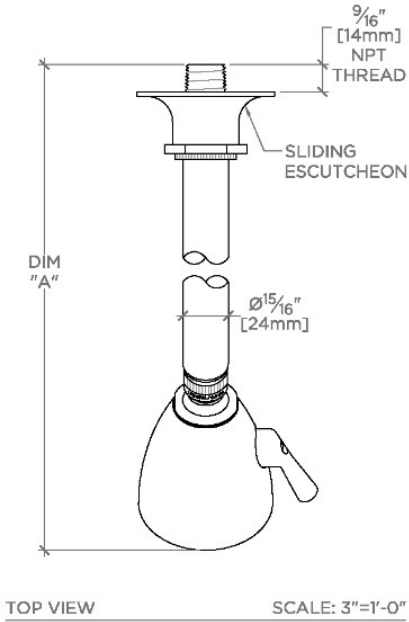

STYLE NO.	DIM "A"	DIM "B"
HNS334	10 1/16" [256mm]	6 1/4" [158mm]
HNS335	12 1/16" [306mm]	8 1/4" [209mm]

