

## FORMWORK

FMS28C

Formwork 8" Rain Showerhead with 6" Ceiling Mounted Shower Arm



SHOWN IN FORMWORK 8" RAIN SHOWERHEAD WITH 6" CEILING MOUNTED SHOWER ARM | FMS28C

### TECHNICAL DETAILS

Adjustable Versus Fixed Spray: Fixed  
Fittings Hole Diameter: 1 1/4"  
Inlet Connection Size: 1/2"  
Inlet Connection Type: Male NPT  
Pivot: Y  
Primary Material: Brass  
Restricted Maximum Flow Rate: 1.75 gpm  
Water Pressure Maximum: 85.0 psi  
Water Pressure Minimum: 20.0 psi  
Water Pressure Recommended: 45.0 psi

### INSPIRATION

Sculptural forms that defy the ordinary. Unexpected geometry and the transition of the planes create a subtle but warm expression.

### CODES & STANDARDS

### PRODUCT FEATURES

Made of Brass

Features a swivel 8" rain showerhead with easy clean rubber nozzles

Includes a 6" ceiling mounted shower arm

Stocked in Brass, Chrome and Nickel

Rain showerhead available in 1.75gpm (6.6L/min) flow rate

### CERTIFICATIONS

### PRODUCT (NOTES)

## FORMWORK

FMS28C

Formwork 8" Rain Showerhead with 6" Ceiling Mounted Shower Arm

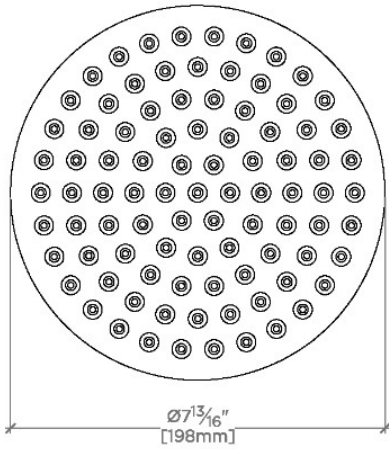

TOP VIEW

SCALE: 3"=1'-0"

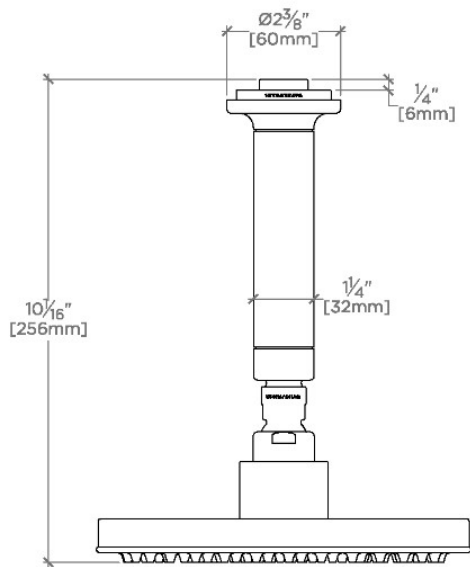

FRONT VIEW

SCALE: 3"=1'-0"

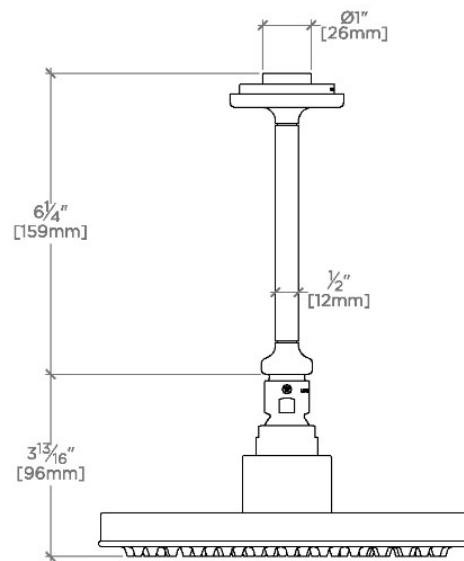

SIDE VIEW

SCALE: 3"=1'-0"