

BOULEVARD

BDS129

Boulevard 12" Rain Showerhead with 22" Wall Mounted 90 Degree Shower Arm



SHOWN IN BOULEVARD 12" RAIN SHOWERHEAD WITH 22" WALL MOUNTED 90 DEGREE SHOWER ARM | BDS129

TECHNICAL DETAILS

Adjustable Versus Fixed Spray: Fixed
Fittings Hole Diameter: 1 1/4"
Inlet Connection Size: 1/2"
Inlet Connection Type: Male NPT
Pivot: Y
Primary Material: Brass
Restricted Maximum Flow Rate: 1.75 gpm
Water Pressure Maximum: 85.0 psi
Water Pressure Minimum: 20.0 psi
Water Pressure Recommended: 45.0 psi

INSPIRATION

Inspiration from 1930s objects evokes extravagance: a strong silhouette, lavish scale and elegant decoration. Machine and artisan hands yield crisp details and curves.

CODES & STANDARDS

PRODUCT FEATURES

Made of Brass

Features a swivel 12" rain showerhead with easy clean rubber nozzles

Includes a 22" wall mounted 90 degree shower arm

Stocked in Brass, Chrome and Nickel

Rain showerhead available in 1.75gpm (6.6L/min) flow rate

CERTIFICATIONS

PRODUCT (NOTES)

WATERWORKS

BOULEVARD

BDS129

Boulevard 12" Rain Showerhead with 22" Wall Mounted 90 Degree Shower Arm

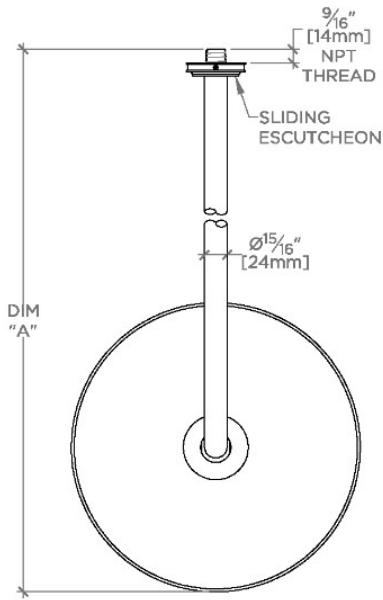

TOP VIEW

SCALE: 1/2"=1'-0"

STYLE NO.	DIM "A"	DIM "B"
BDS128	24 ⁵ / ₈ " [625mm]	18 ⁹ / ₁₆ " [472mm]
BDS129	28 ⁵ / ₈ " [727mm]	22 ⁹ / ₁₆ " [573mm]

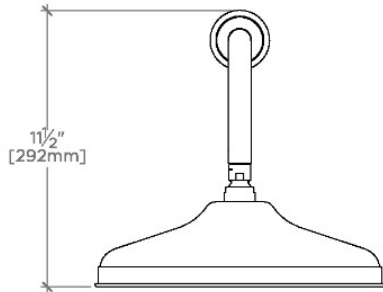

FRONT VIEW

SCALE: 1/2"=1'-0"

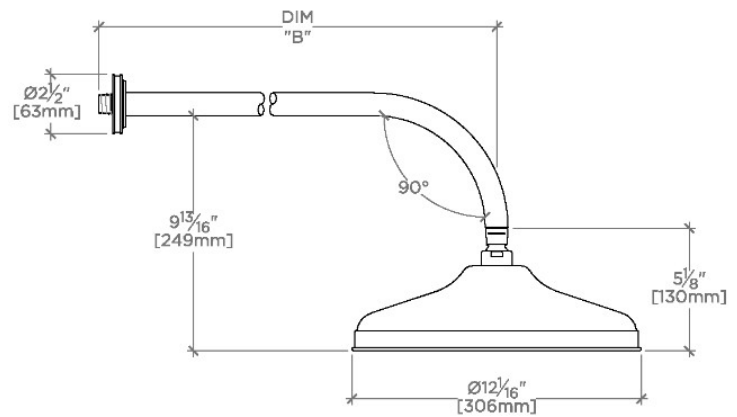

SIDE VIEW

SCALE: 1/2"=1'-0"