

3/4" Thermostatic Valve w/ 3 - way Diverter

1-137

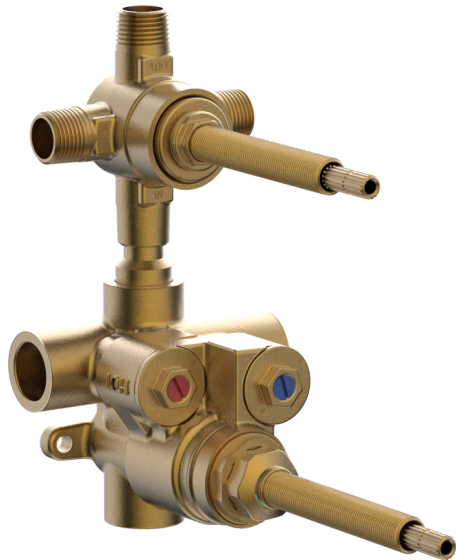

VALVE SPECIFICATIONS

Female 3/4" NPT inlets and outlets
 Factory temperature setting = 100°F (38°C)
 Temperature range = 52° to 118°F (11°-48°C)
 Temperature hot supply = 149° to 180°F (65°-82°C)
 Temperature cold supply = 50° to 72°F (10°-22°C)
 Temperature stability = ±32°F (0°C)

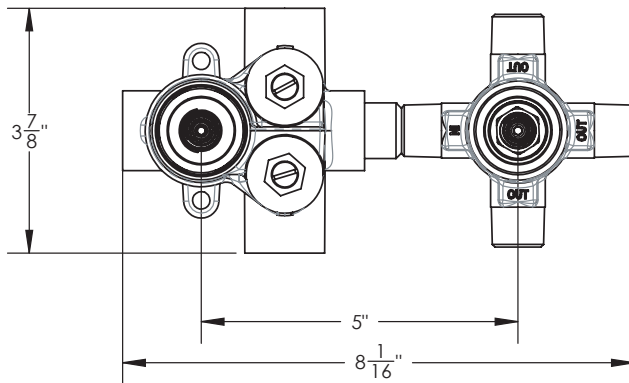

CODES & STANDARDS

ASME A112.181/ CSA B125.1, ASME 112.18.2/ CSA B125.2, ANSI NSF, CEC, Watersense 61 Sect. 9, State of MA.



WARRANTY

Mechanical Warranty: 10 Years from date of purchase.

