

BCR-H-3060 Series

Curbless Stainless Steel Shower Base with Right Drain Location

- BCR-H-3060QS - Squares Pattern Complete Kit
- BCR-H-3060NS - Lines Pattern Complete Kit
- BCR-H-3060TI - Tile Insert Complete Kit
- BCR-H-3060WS - Perforated Grate Complete Kit

Features

- | | |
|--|--|
| <ul style="list-style-type: none"> ▪ Pre-pitched shower base at optimal 1/4" per foot ▪ 16 Gauge, 304L stainless steel base ▪ Decorative covers available in 7 Gauge, 304L decorative patterns or 16 Gauge, 304L stainless steel tile inserts ▪ Includes 1/2" tile edge with weep holes ▪ Integral 3 1/2" curbless flange | <ul style="list-style-type: none"> ▪ Pre-primed surface - ready to be tiled ▪ Provided with High Density EPS Foam support ▪ Flow rate - 9 gpm per outlet <ul style="list-style-type: none"> ▫ Flow rate measured at outlet only. Measurement does not account for water in channel or sheeting on shower floor ▪ Provided with Lifetime Guarantee* <p><small>*See ID Guarantee for full information</small></p> |
|--|--|

Installation

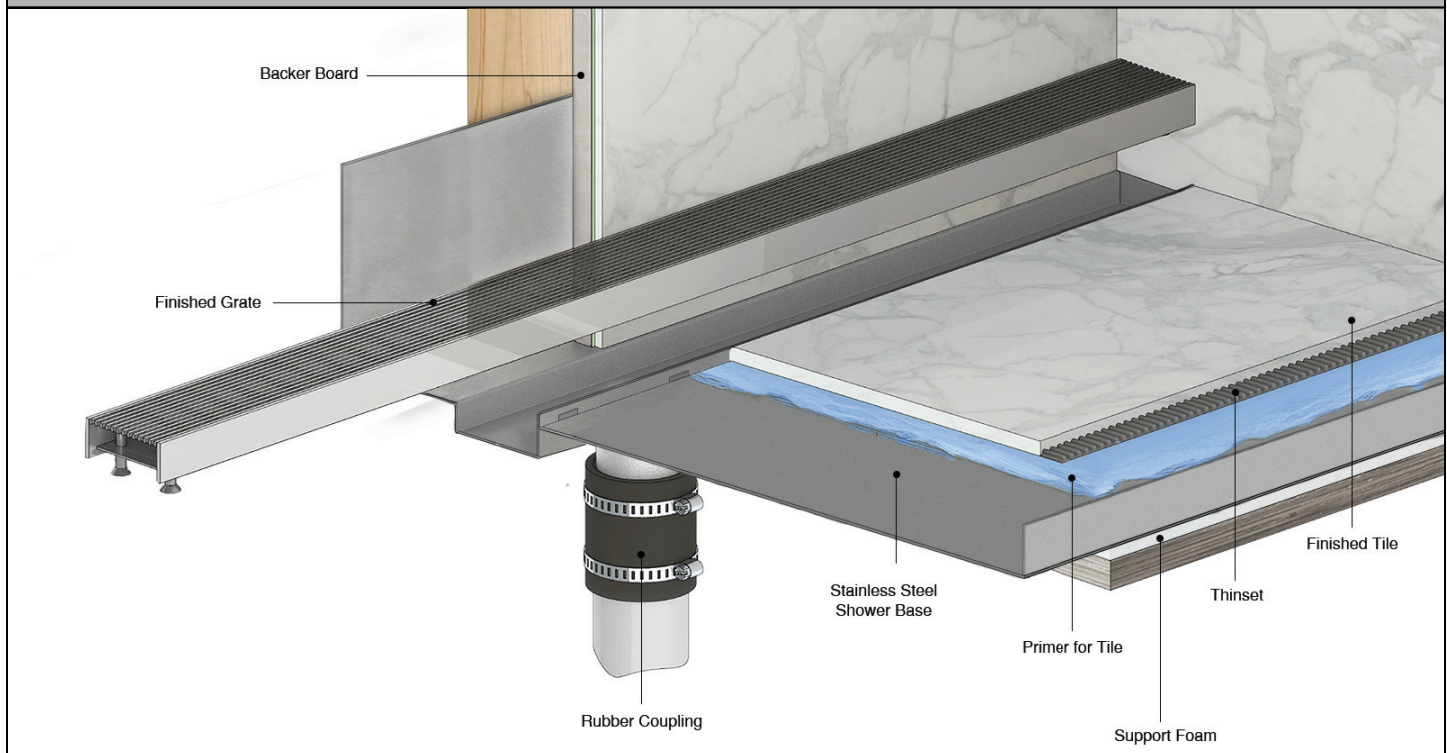

Care & Maintenance

Stainless steel shower bases and linear grates are made of 304L and 316L stainless steel. This material is non-porous, hygienic, rust-free and extremely durable. Bar Keepers Friend® and Soft Scrub® are commonly available products that can be used to protect and clean your Satin Stainless drain cover. For stains that have been left for an excessive amount of time, stronger cleaning agents such as Steel Brite® may be needed. For Polished Stainless and other finishes we recommend a mild soap and a soft cloth for cleaning. DO NOT use any abrasive cleaners, scrub pads or allow household cleaning agents, such as bleach, to sit on the drain cover for a long period of time. Stainless steel does not rust. External factors, such as contamination from other highly ferrous metals, built up road salt, sea salt, or chlorine may have caused "surface" rust which can be removed using Barkeepers Friend®, Soft Scrub®, or Steel Brite®. Always follow the directions on the bottle. Follow proper maintenance procedures to prevent excessive surface rust. In areas of frequent exposure to salt, chlorine, and other chemical compounds, maintenance of the stainless grates should be performed at least 2-3 times per year.

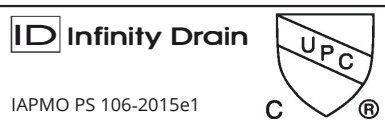

Infinity Drain
 145 Dixon Avenue
 Amityville, NY 11701
 Phone: 516.767.6786
 Fax: 516.740.3066
 www.infinitydrain.com

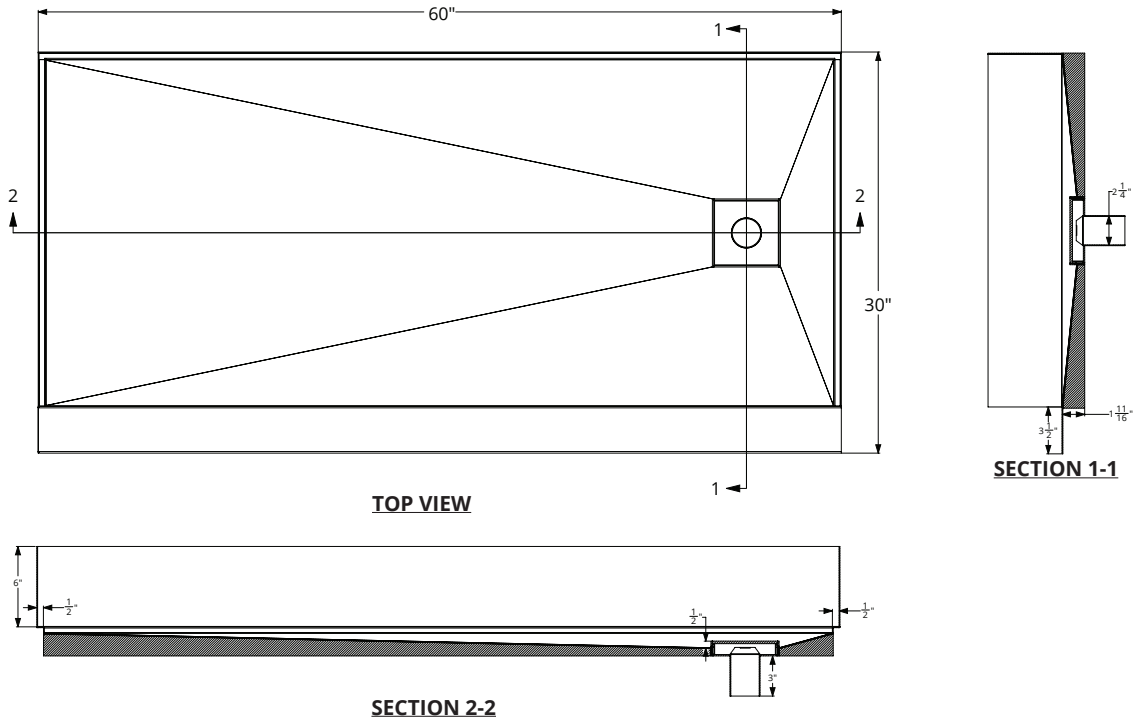

NOTE: Installer must verify all rough-in dimensions prior to installation and consult local and national codes. Conformity and compliance to local and national codes are the responsibility of the installer.

ID Infinity Drain®

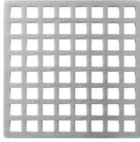

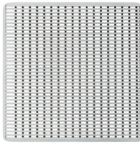
Model Number	Complete Kit Includes
<input type="checkbox"/> BCR-H-3060QS 	1 - Stainless Steel Shower Base 1 - QS 5" x 5" Squares Pattern Decorative Cover 1 - BGF Grate Frame for Cover 1 - HS 2 Hair Strainer 1 - AKEY Lift Out Key
<input type="checkbox"/> BCR-H-3060NS 	1 - Stainless Steel Shower Base 1 - NS 5" x 5" Lines Pattern Decorative Cover 1 - BGF Grate Frame for Cover 1 - HS 2 Hair Strainer 1 - AKEY Lift Out Key
<input type="checkbox"/> BCR-H-3060TI 	1 - Stainless Steel Shower Base 1 - BTI - 5" x 5" Tile Insert Cover 1 - HS 2 Hair Strainer 1 - AKEY Lift Out Key
<input type="checkbox"/> BCR-H-3060WS 	1 - Stainless Steel Shower Base 1 - WS 5" x 5" Wedge Wire Decorative Cover 1 - BGF Grate Frame for Cover 1 - HS 2 Hair Strainer 1 - AKEY Lift Out Key

Stock Finishes

- Satin Stainless
 Polished Stainless
 Matte Black
 Satin Bronze
 Oil Rubbed Bronze

Infinity Drain
 145 Dixon Avenue
 Amityville, NY 11701
 Phone: 516.767.6786
 Fax: 516.740.3066
 www.infinitydrain.com



NOTE: Installer must verify all rough-in dimensions prior to installation and consult local and national codes. Conformity and compliance to local and national codes are the responsibility of the installer.