

SoftClose, Quick-release Elongated Seat
US-SEATU1

Installation Instructions

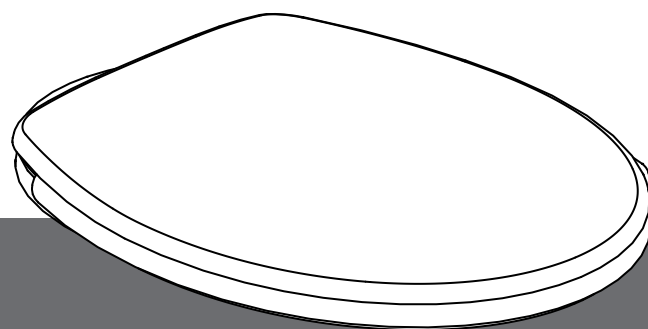

Introduction

IMPORTANT: Please read these instructions carefully before beginning and retain for future reference. These instructions have been prepared for your guidance; you must exercise due care at all times.

We do not accept responsibility for any problems that may occur through incorrect installation.

Installation notes

Before installation, please check that all parts have been supplied and that no damage has occurred during transport.

Note: Damage claims cannot be made during or after installation.

All the fittings shown are workable for installation.

Parts supplied

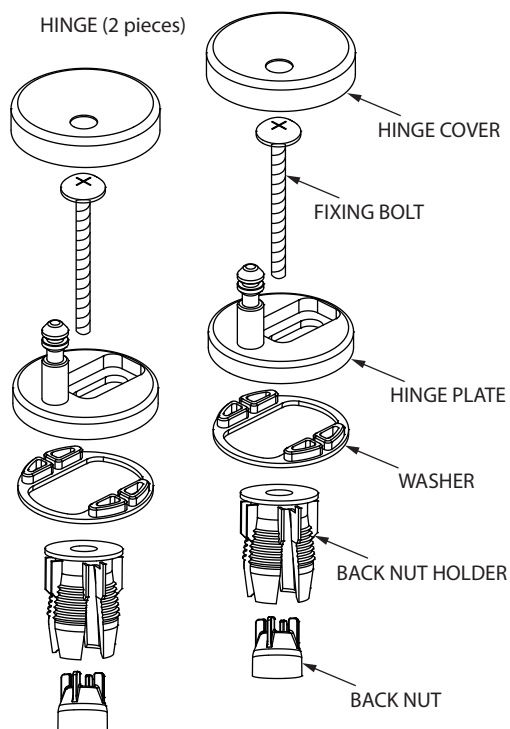
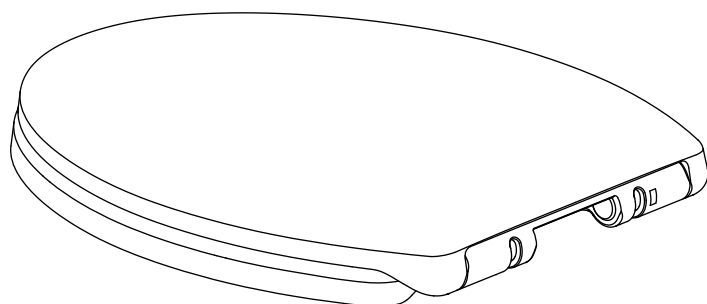

Tools required

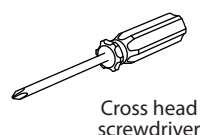
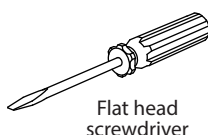

Installation

1

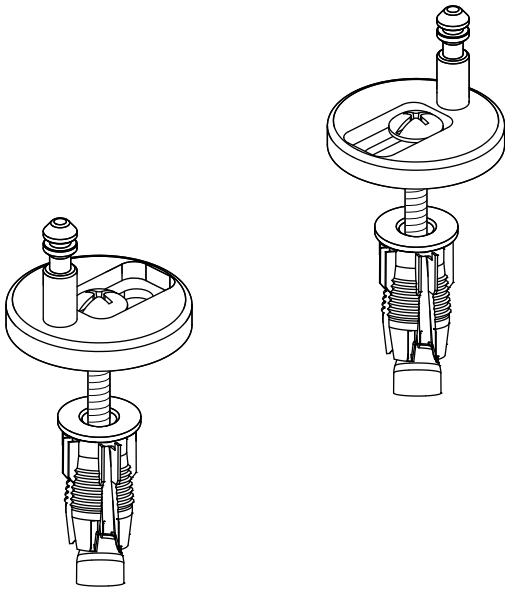

2

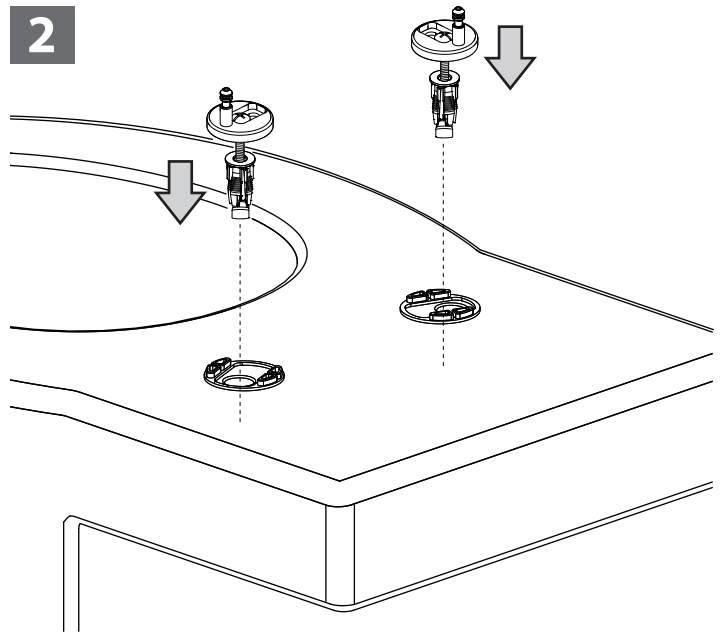

3

DO NOT overtighten.

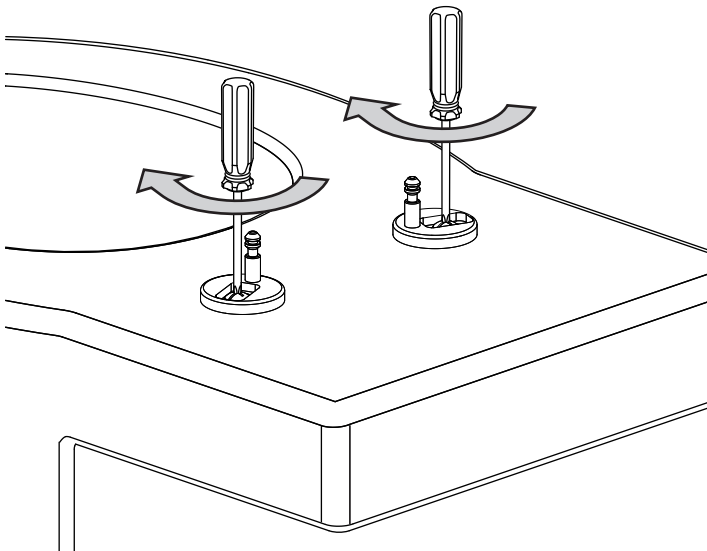

4

Before attaching the seat, move the mounting base so that the posts align with the holes in the back of the seat. Once aligned, carefully lower the seat (holes) onto the mounting post.

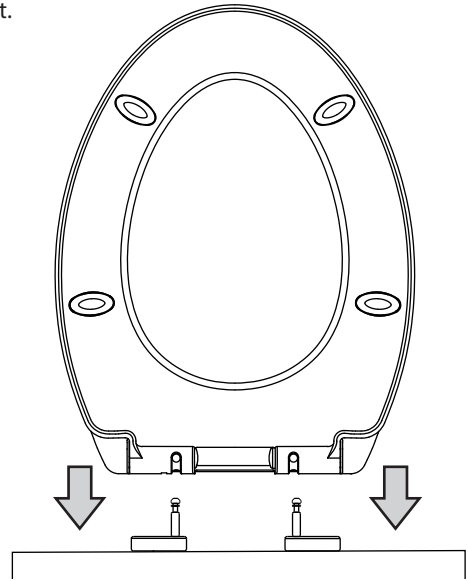

5

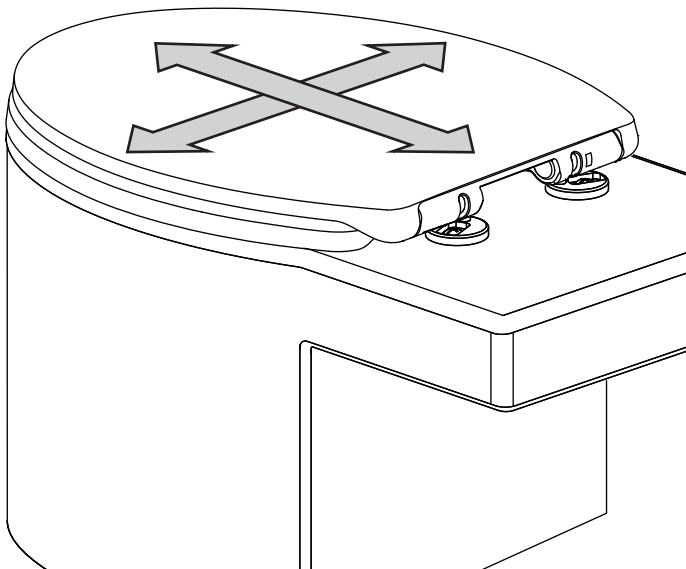

6

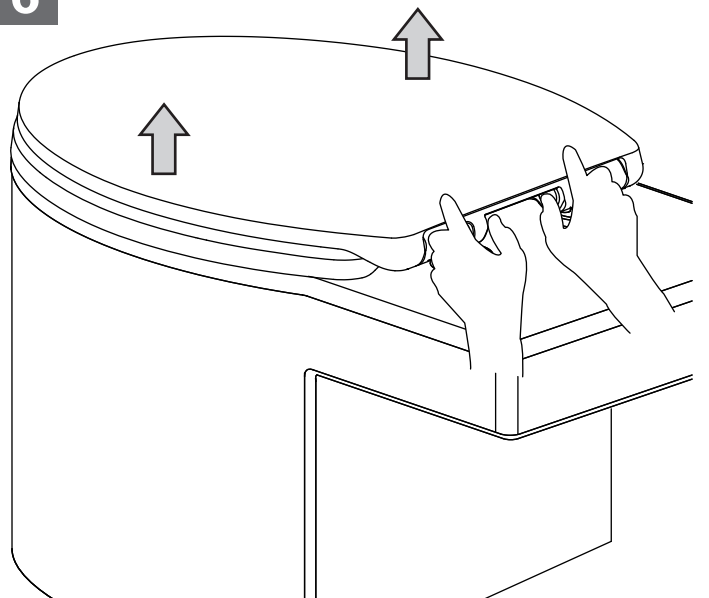

Installation

7 Once satisfied with the position, fully tighten the screws.

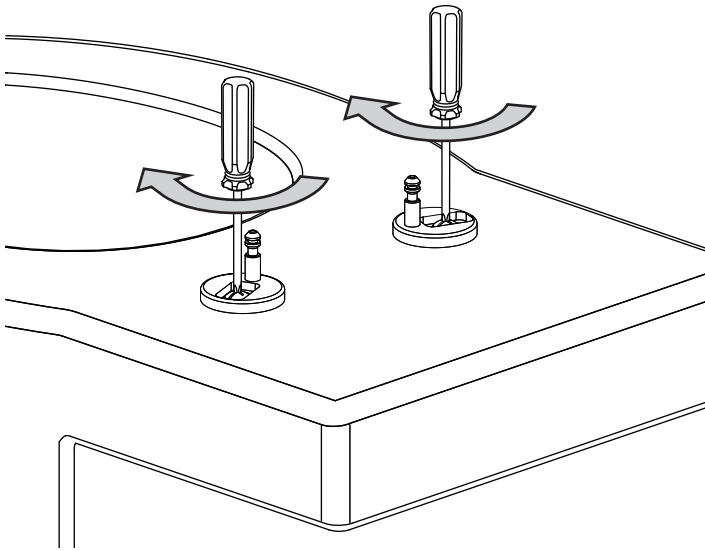

8

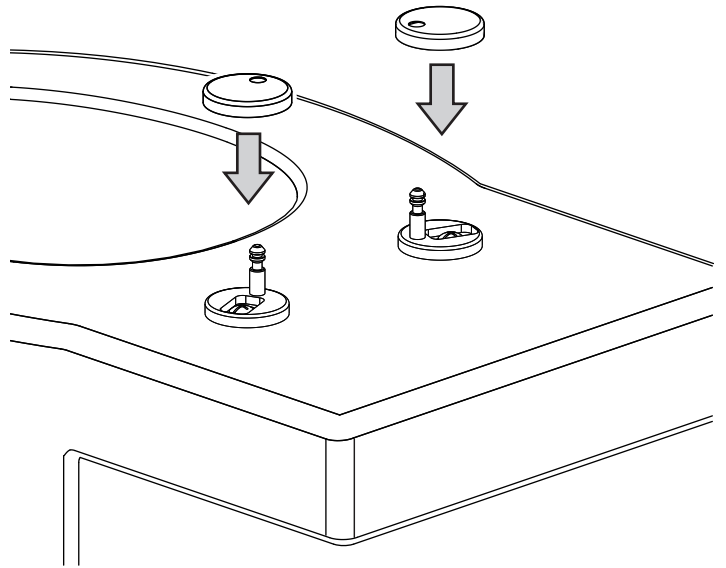

9 When mounting the seat make sure the posts align with the holes in the back of the seat. Carefully lower the seat back into place (a "click" will heard).
NOTE: Do not push hard or force the seat onto the posts. (If difficult, re-check alignment.)

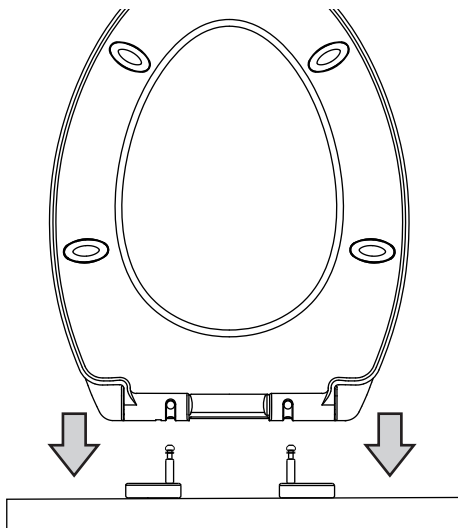

10 To remove the seat, press the quick-release button (you should hear a "click")

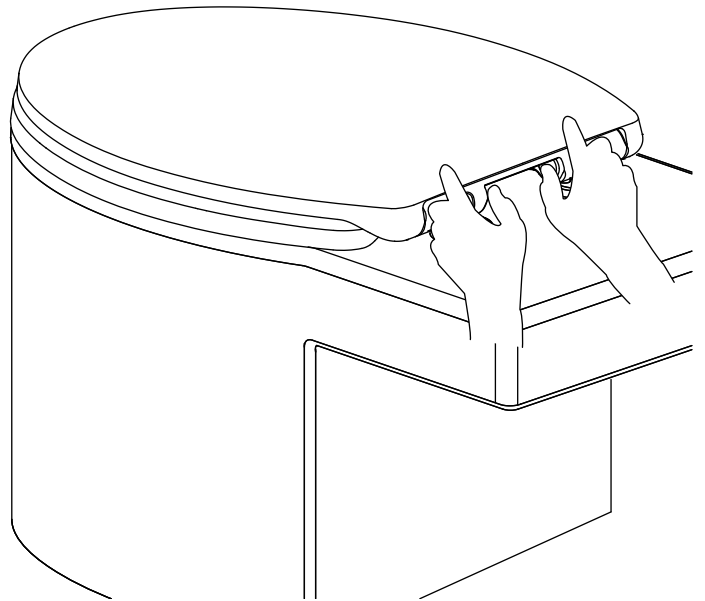

11 Open the seat to the vertical position, then lift the seat straight up with one hand.

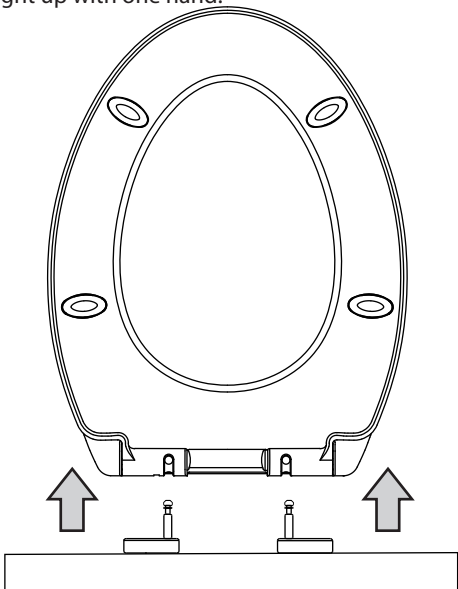

12 Cleaning Instructions

Use a soft, damp cloth and a mild soap such as dishwashing liquid to clean the seat. Rinse the seat and dry with a soft towel. Do not use abrasive cleaners as they will scratch and dull the surface. Do not allow cosmetics or abrasive chemicals to come in contact with the toilet seat.

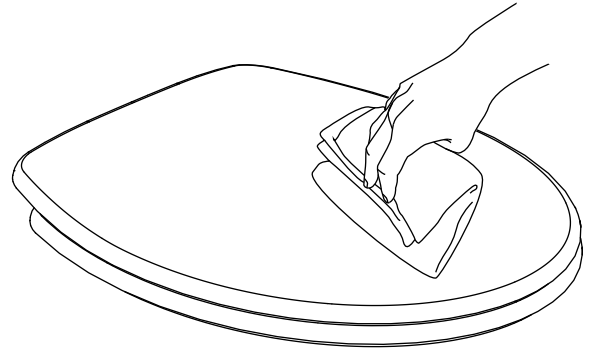

Warranty - Crosswater London toilet seats are covered by a one-year warranty. For full details, terms and conditions please visit our website.

For further information contact: **Crosswater London**, 393 Fortune Blvd., Milford, MA 01757

www.crosswaterlondon.com

Toll free number: 844-XWATER-1 (844-992-8371) tel: 508-381-0433 fax: 508-381-6068

email: technical@crosswaterlondon.com

Issue date: 20112019